

AUTOMATE™

Li-ion Solar Charging Power Panel



SOLAR
POWERED

AUTOMATE | Li-ion Solar charging power panel provides supplemental power to all Li-ion wirefree motors or rechargeable battery packs.

The monosilicon/crystal solar panel provides power in varied conditions including low light situations. Panels can also be wired in parallel to provide additional power for larger applications.

Users can refer to the AUTOMATE Solar Guide for direction related to regional solar conditions and expected performance.

FEATURES:

- Plug n' play for all AUTOMATE Li-ion motors & rechargeable battery packs
- Sleek design allows for unobtrusive placement behind most headrails
- Parallel wiring options support large shades
- Monosilicon/crystal technology allow for up to 30% more efficiency than alternatives
- Low light harvesting technology supports power generation in varied conditions

CONTENTS

1	INSTALLATION	5
2	DIMENSIONS	7
3	TROUBLE SHOOTING	8

KIT COMPONENTS

1. Solar Panel
2. Solar Panel Mounting Bracket
3. PV Voltage Regulator
4. Double Sided Adhesive Tape x 2
5. Cable Tie x 2
6. Alcohol Wipe x 2
7. Installation Instructions

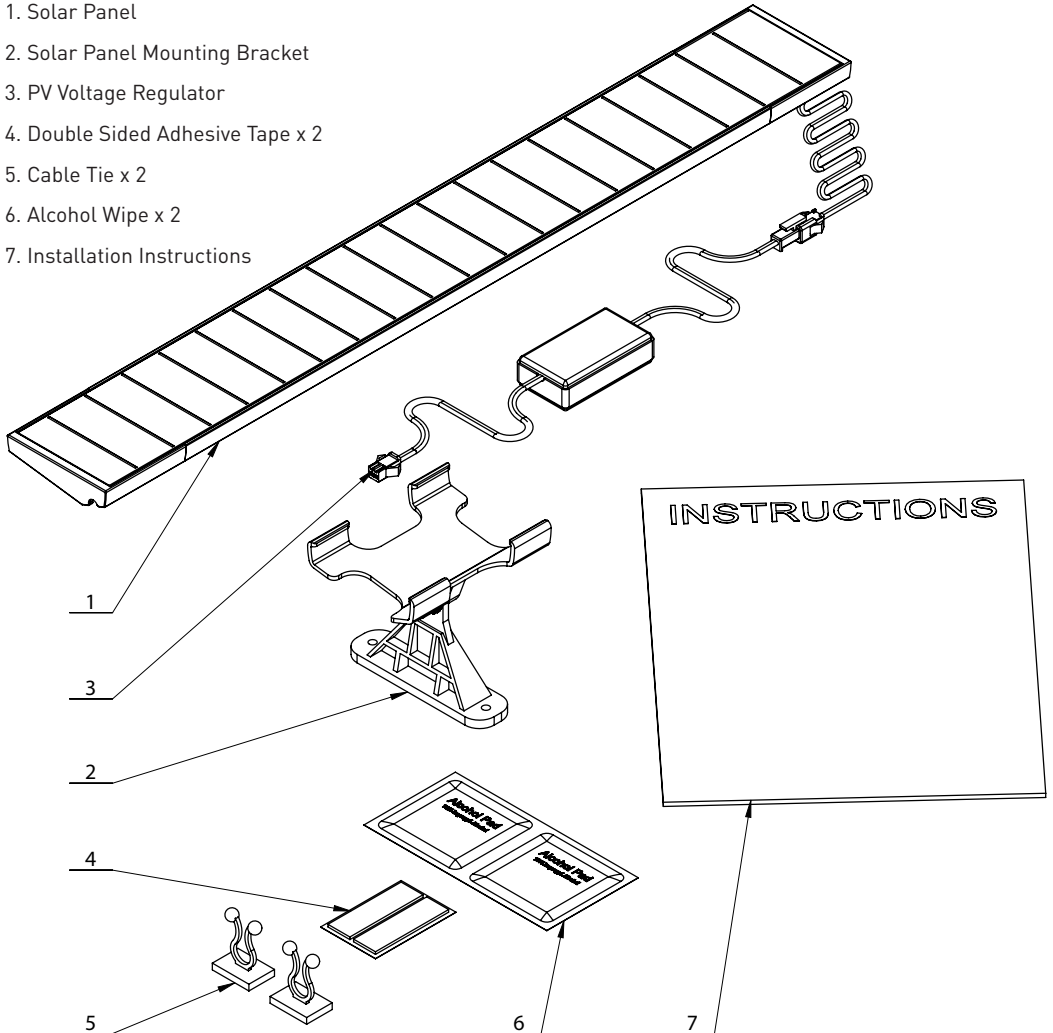

SAFETY INSTRUCTIONS

WARNING: Important safety instructions to be read before installation.

Incorrect installation can lead to serious injury and will void manufacturer's liability and warranty.

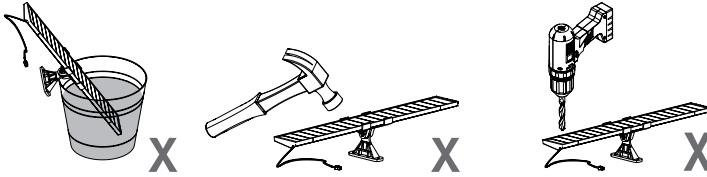

CAUTION

- Do not expose to moisture or extreme temperatures.
- Do not allow children to play with this device.
- Use or modification outside the scope of this instruction manual will void warranty.
- Installation and programming to be performed by a suitably qualified installer.
- For use with Li-ion motors only.
- Do not cut power cables.
- Use only Rollease Acmeda hardware.
- Do not expose the Solar panel to water or install in humid or damp environments.
- Do not drill into motor body.
- The routing of cable through walls shall be protected by isolating bushes or grommets.
- Ensure power cable and aerial is clear and protected from moving parts.
- If cable or power connector is damaged do not use.

Important safety instructions to be read prior to operation.

- It is important for the safety of persons to follow the enclosed instructions. Save these instructions for future reference.
- Persons (including children) with reduced physical, sensory or mental capabilities, or lack of experience and knowledge should not be allowed to use this product.
- Keep remote controls away from children.
- Frequently inspect for improper operation. Do not use if repair or adjustment is necessary.



Do not dispose of in general waste.
Please recycle batteries and damaged electrical products appropriately.



1 INSTALLATION

Step 1. Locate the optimal position for solar panel in window.



IMPORTANT!

Avoid any partial covering of any solar panel cell.

Ensure solar panel has adequate exposure to sunlight.

When selecting a position for solar panel, consider any external obstructions like trees, building, signs, etc. that may limit the amount of sun light reaching onto the solar panel.

Step 2. Installing Solar panel

OPTION A. Attaching Mounting Bracket to Window Frame

- i. Install mounting bracket to wall/mounting point.
- ii. Fix Solar panel to mounting bracket.

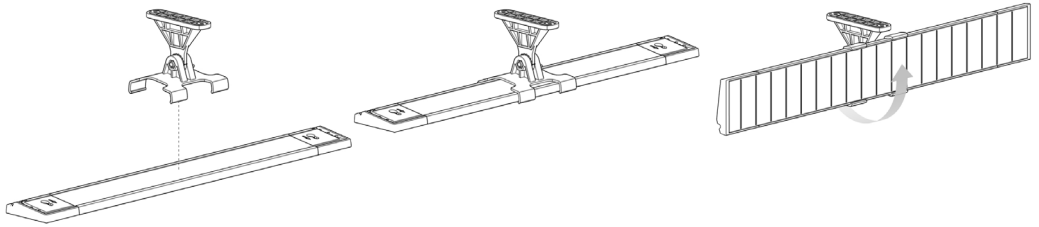

OPTION B. Attaching Solar Panel via Adhesive Tape to a Window or surface

- i. Clean Solar panel front surface with alcohol wipe.
Allow surface to dry.
- ii. Peel protective film off one side of adhesive tape and attach to one end of Solar panel.
Press adhesive tape firmly onto Solar panel surface for 5 seconds to ensure good adhesion.
Ensure that adhesive tape does NOT cover any portion of the Solar panel cells.
Repeat previous steps for attaching adhesive tape to other end of Solar panel.

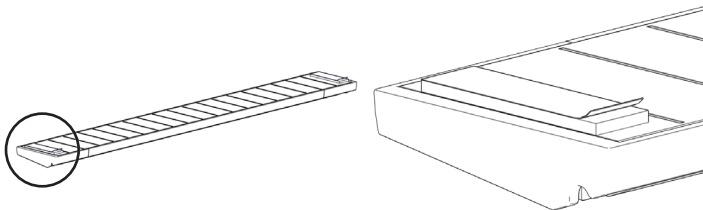

IMPORTANT!

Any partial or total covering of any solar panel cell will affect solar panel performance.

OPTION B. continued...

iii. Clean the window or surface with alcohol wipe.

Allow surface to dry.

Peel protective film off adhesive tapes.

Press firmly onto fixing surface.

Apply hand pressure for 5 seconds and check if firmly attached.

Step 3. Solar panel is provided with voltage regulator already attached.

If voltage regulator is not attached to Solar panel, connect panel power cable (female) connector to voltage regulator cable (male) connector.

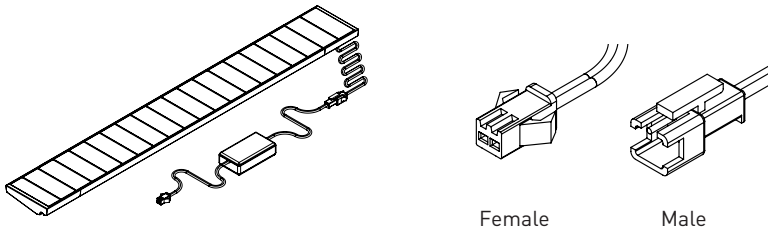

Step 4. Follow STEP 2 (OPTION B) to fix cable ties in place, only if required.

Step 5. Connect voltage regulator cable (female) connector to motor cable (male) connector.

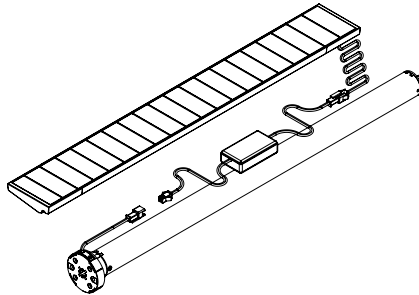

Step 6. Follow STEP 2 (OPTION B. iii) to fix the voltage regulator onto a suitable surface (wall, Solar panel, window), if required.



IMPORTANT!

Ensure cable is kept clear of fabric at all times.

2 DIMENSIONS

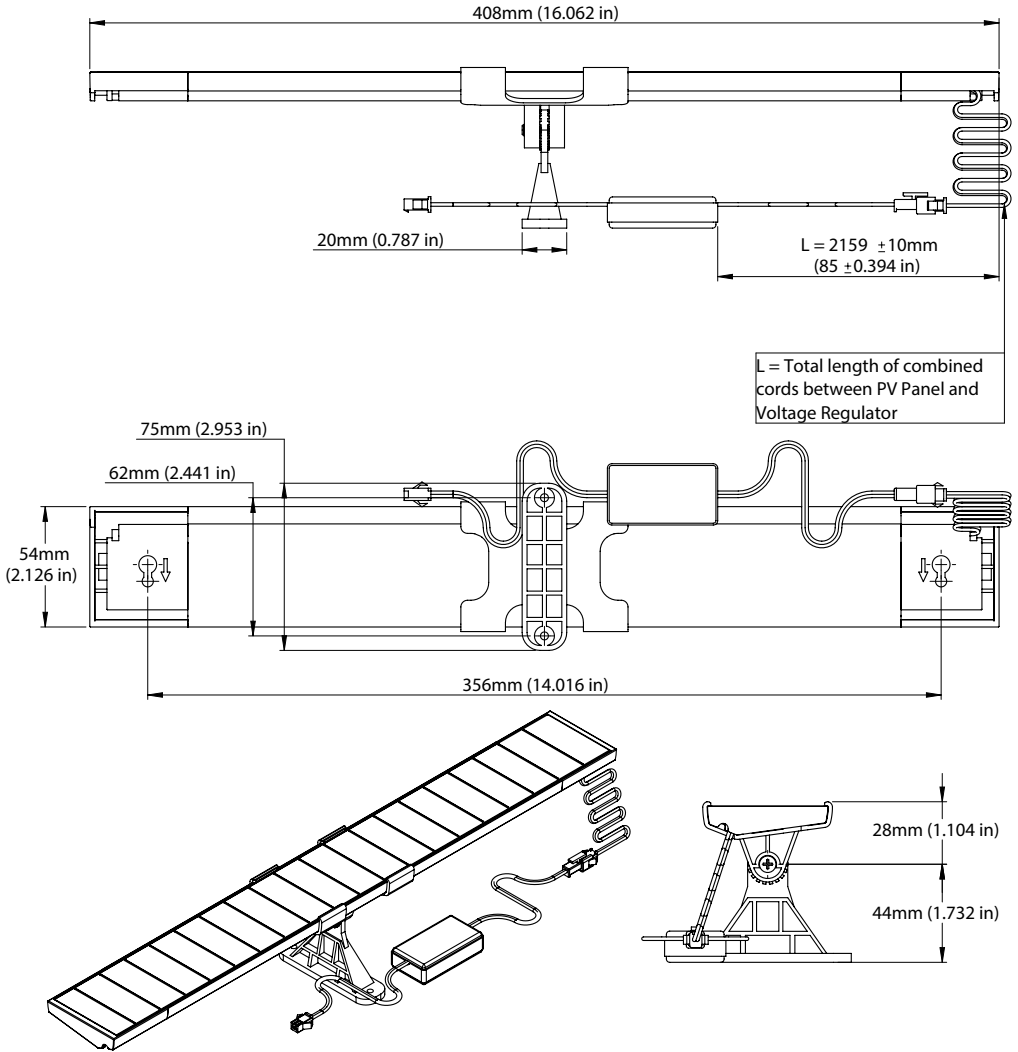

SPECIFICATION TABLE

Parameters		Value
Power	W	3
Voltage (open circuit)	Voc	23.4
Current (short circuit)	Isc	200
Max. Point Voltage	Vmp	18
Max. Point Current	Imp	160

3 TROUBLE SHOOTING

Problem	Cause	Remedy
Motor is not responding	Remote control battery is discharged	Replace battery
	Battery is inserted incorrectly into remote control	Check battery polarity
	Radio interference/shielding	Ensure remote is positioned away from metal objects and the antenna on motor is kept straight
	Motor distance is too far from remote control	Move Remote to a closer position
	Battery power depleted	Recharge with AC adapter (Optional)
	Incorrect wiring	Check that motor wiring is connected correctly (refer to motor installation instructions)
Motor beeps 10 times when in use	Battery voltage is low / Solar Panel issue	Check connection and positioning of Solar panel. Ensure sun exposure is adequate.
	Solar Panel not providing enough power	Recharge with AC adapter (Optional)

ROLLEASE ACMEDA | AUSTRALIA

110 Northcorp Boulevard,
Broadmeadows VIC 3047
T +61 3 9355 0100 | F +61 3 9355 0110

ROLLEASE ACMEDA | USA

200 Harvard Avenue
Stamford, CT 06902 6320
T +1 203 964 1573 | F +1 203 964 0513

ROLLEASE ACMEDA | EUROPE

Via Conca Del Naviglio 18, Milan
(Lombardia) Italy
T +39 02 8982 7317 | F +39 02 8982 7317

info@rolleasacmeda.com
rolleasacmeda.com
